









Smart lift SL408 Outdoor

Product information and specifications

STANDARD EQUIPMENT

- Electric actuators secure precise installation
- Side shift 100 mm to each side
- Reliable 2 circuit vacuum system
- Easy to handle
- Recognized danish quality
- 500 W propeling engine
- Improves work environment
- Multi functional
- It is easy to transport by its own force over a platform in any van or trailer
- SmartLift was honoured with Swedish prize for improving work environment in 2007

DIMENSIONS

	Width (min)	650 mm
	Length (min)	2100 mm
	Extention of arm	500 mm
	Side shift	100 mm
	Height	1350 mm
	Tip from horizontal	50° backwards / 100° forward
	Propelling engine	500 Watt
	Battery (2 x 12 V) 24 Volt	2 x 60 A
	Running period	Approx. 30 hours
	Integrated charger	Cetek XT 14000
	Charging time	Approx. 8 hours
	Voltage charger	230 volt
	Vacuum system	2 circuits
	Suction pads	4 x Ø300 mm
	Automatic suction	Yes
	Weight	570 kg

LOADING DIAGRAM

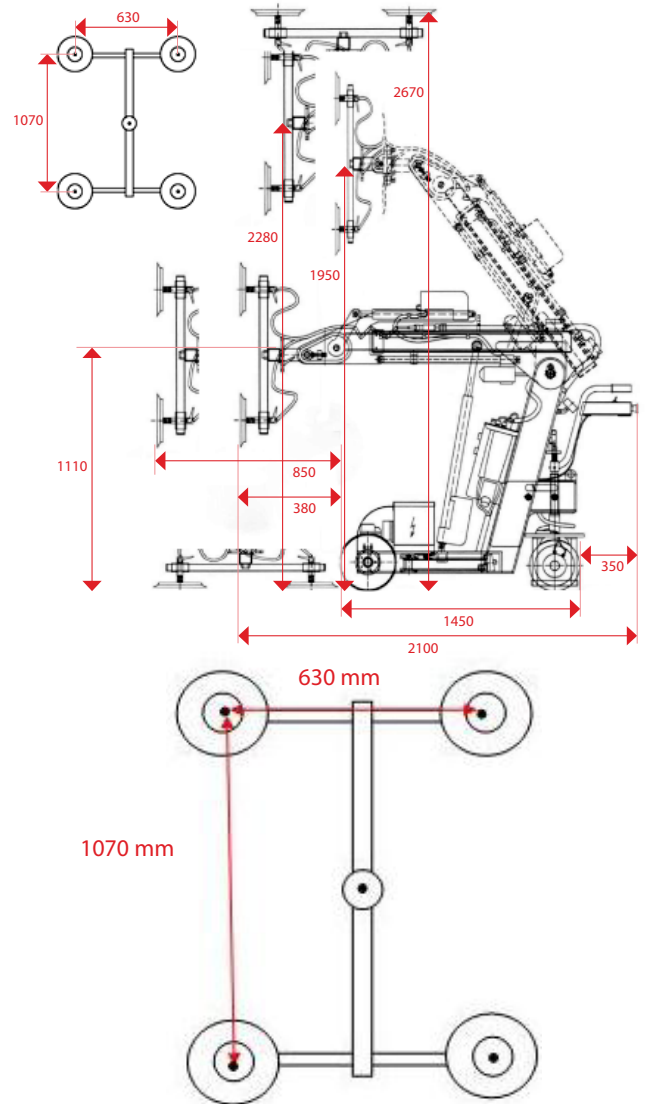

www.instant.no